

# 787 ProcessMeter

## Quick Reference Guide

**Warning**

To prevent possible electrical shock, fire, or personal injury, read the "787 Safety Information" before you use this Product.

Go to [www.fluke.com](http://www.fluke.com) to register your product and find more information.

### mA / Hz

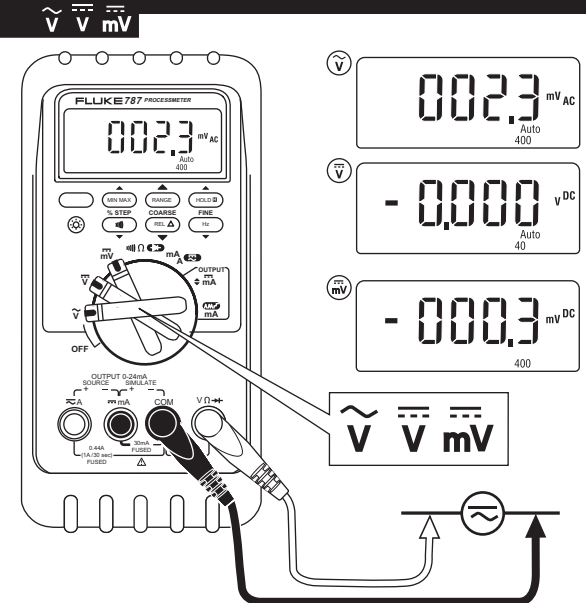
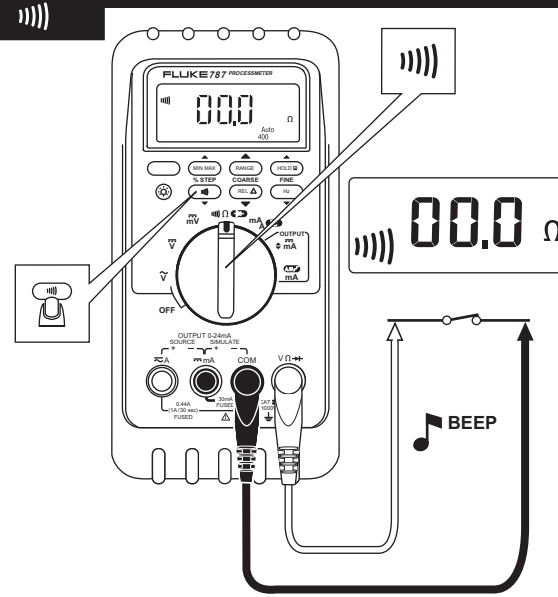
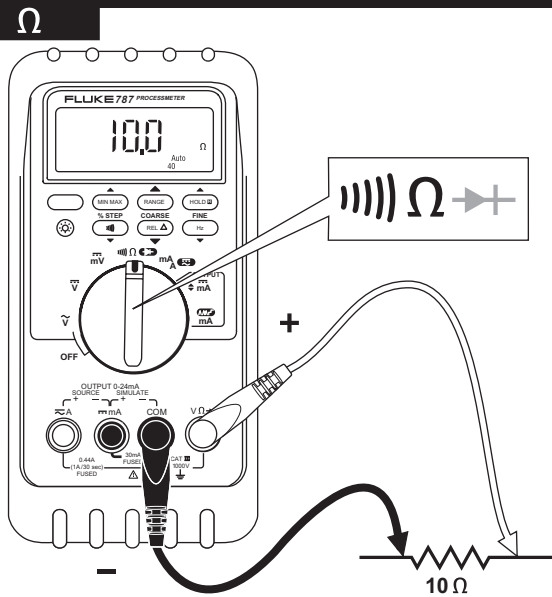
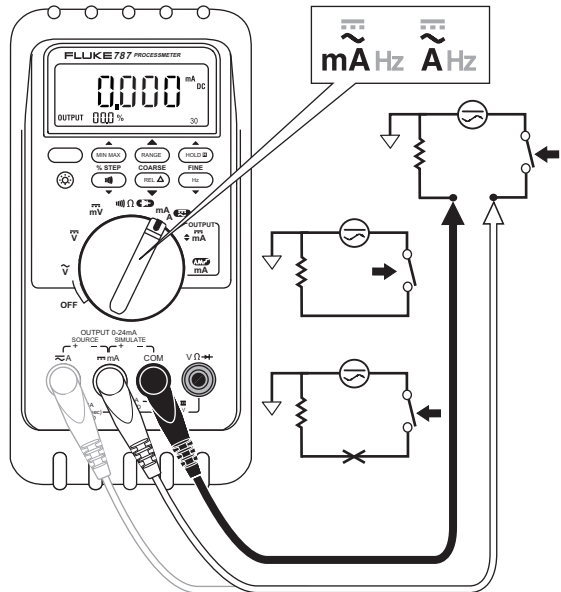

### Measurement MIN MAX

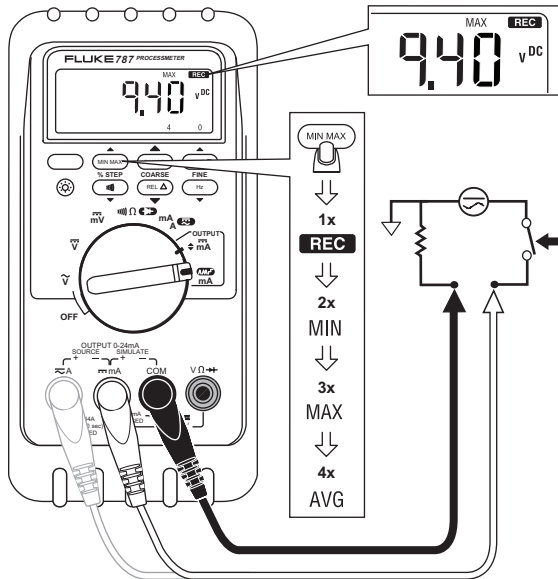

### Output Source

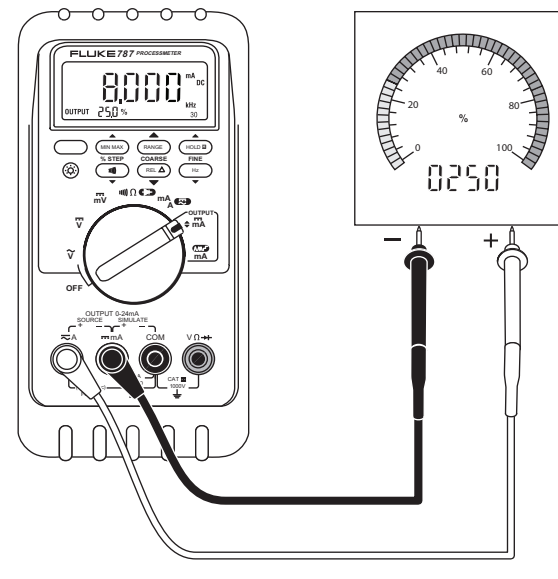

### Output Simulate

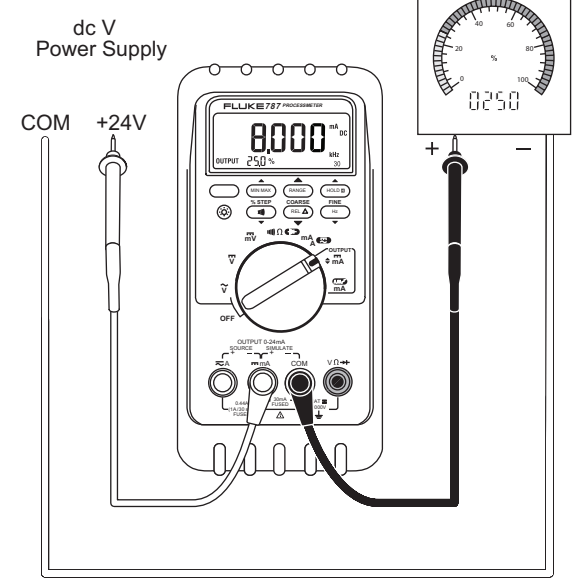

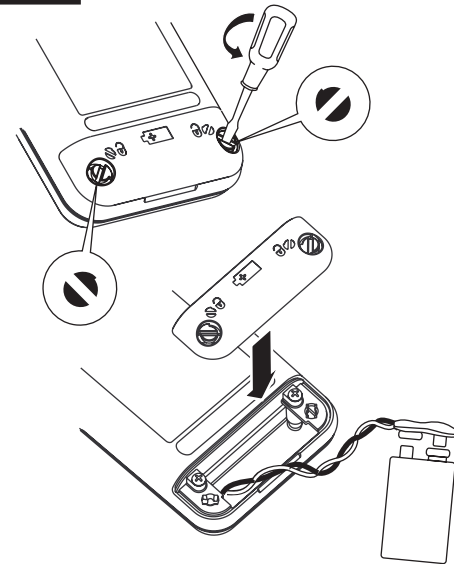
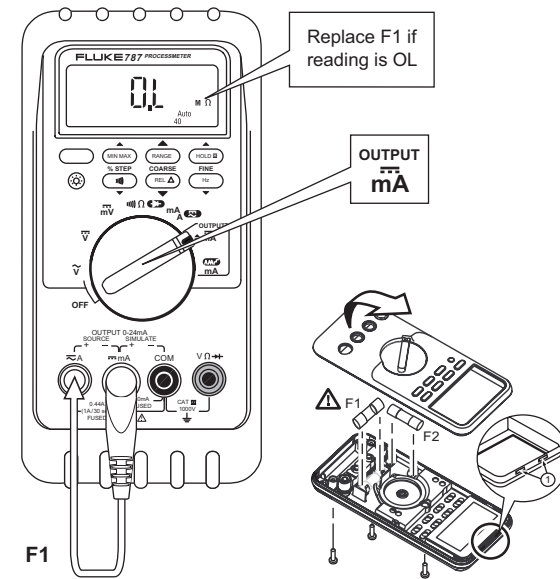
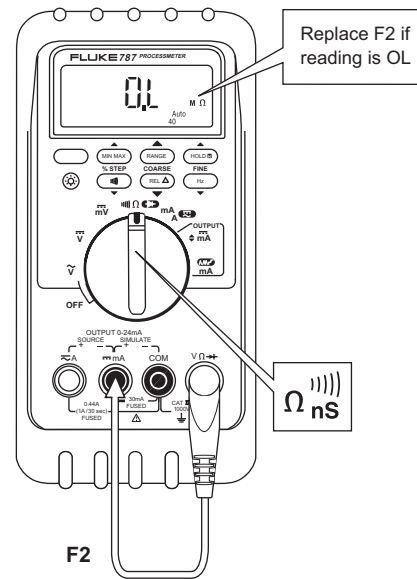
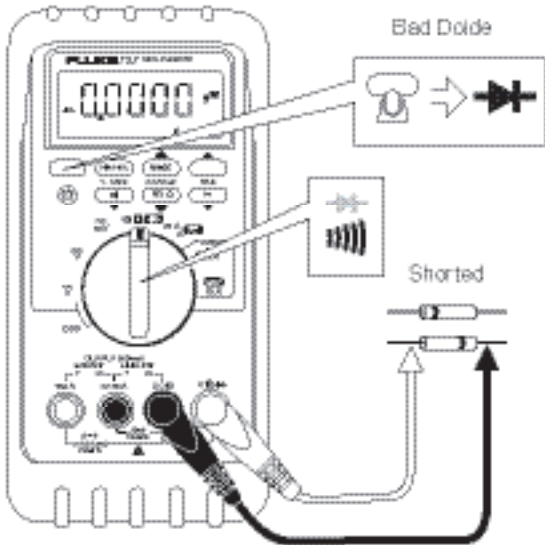
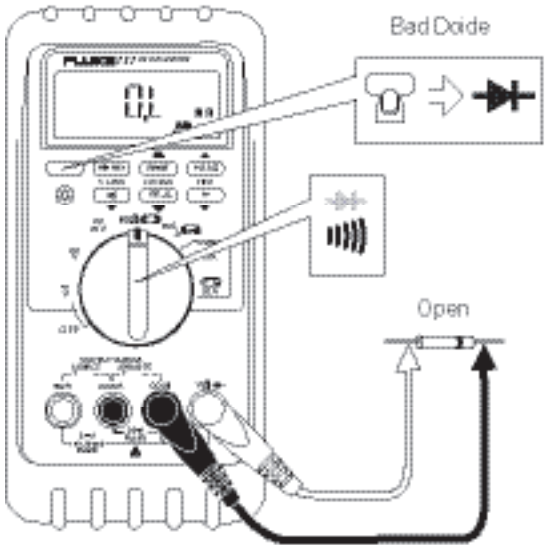
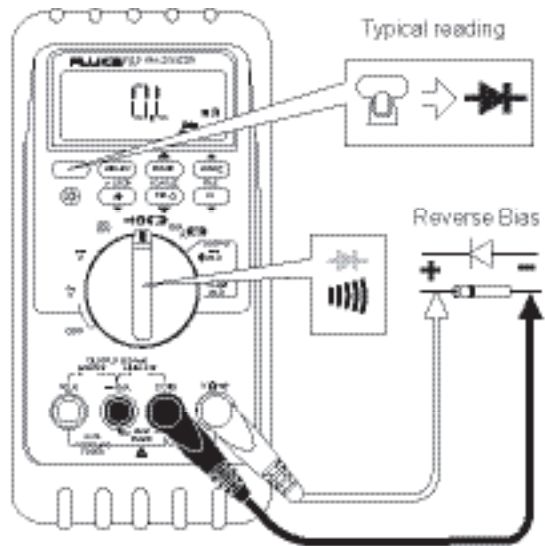
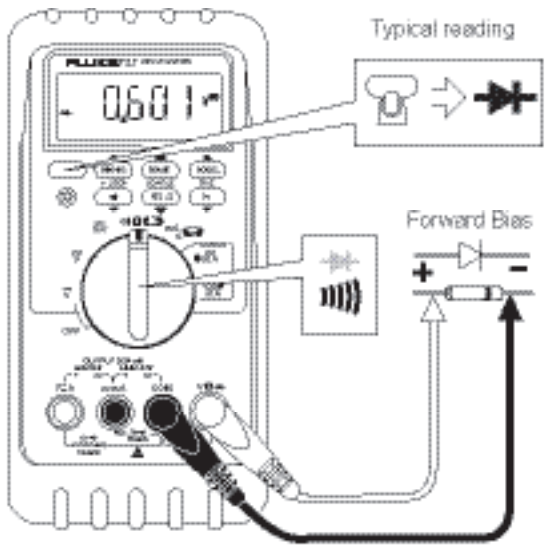

### ToolPak

